

目 录

一、运输作业组织与管理模块..... 2

二、仓储与配送作业组织与管理模块..... 34

三、国际物流作业组织与管理模块..... 150

四、 快递物流作业组织与管理模块.....	213
-----------------------	-----

湖南商务职业技术学院物流管理专业学生技能考核题库

一、运输作业组织与管理模块

○

○

○

--	--	--

○

○

--	--	--	--	--

() 任务描述

- :
-
-



<input type="checkbox"/> <input type="checkbox"/>				<input type="checkbox"/> <input type="checkbox"/>				
<input type="checkbox"/> <input type="checkbox"/>								
						<input type="checkbox"/> <input type="checkbox"/> <input type="checkbox"/> <input type="checkbox"/>		



() 任务描述:

-
-
-



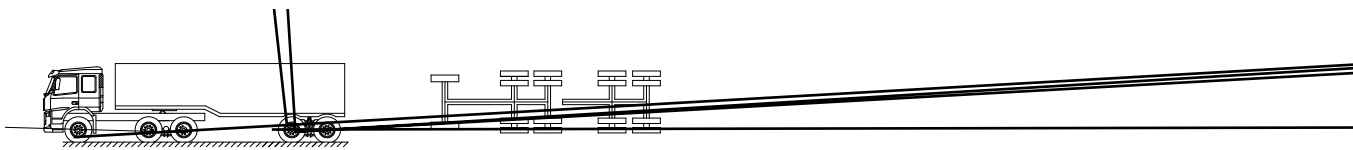

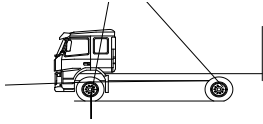
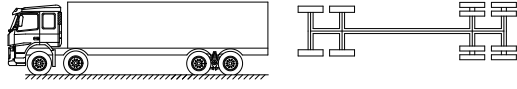
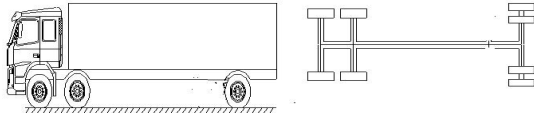

() 任务描述:

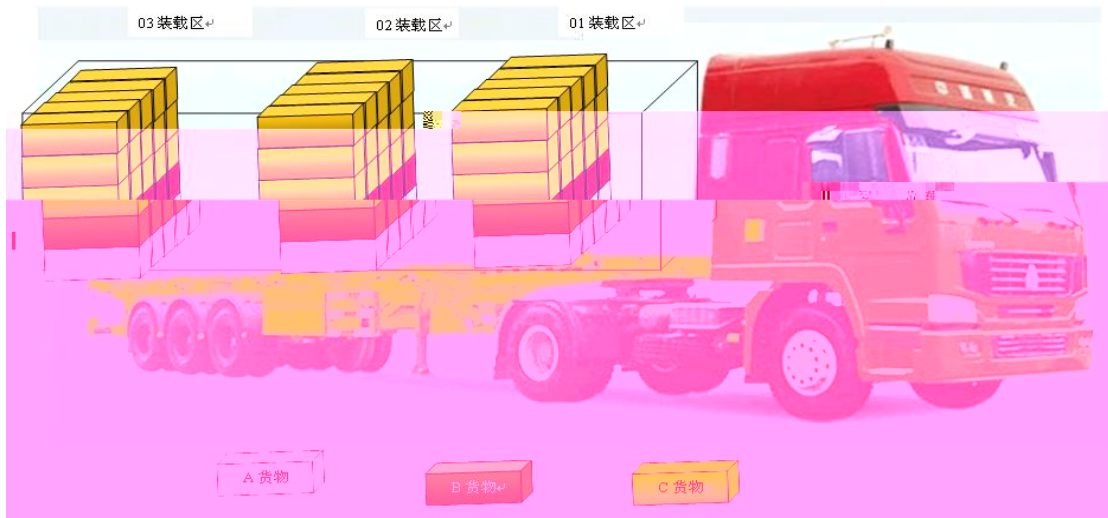

○

○

○

○

○

() 任务描述



D

<input type="checkbox"/> <input type="checkbox"/>			<input type="checkbox"/> <input type="checkbox"/>						
<input type="checkbox"/> <input type="checkbox"/>									
						<input type="checkbox"/> <input type="checkbox"/> <input type="checkbox"/> <input type="checkbox"/>			



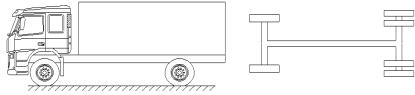
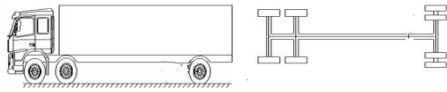
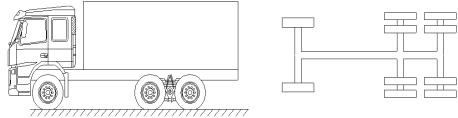

2

3

4

() 任务描述



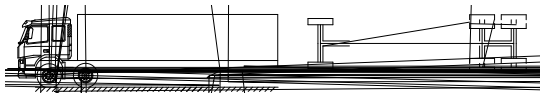
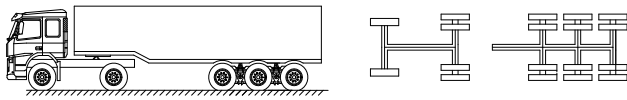
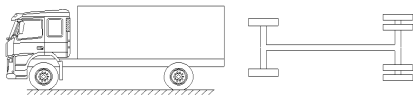



() 任务描述

-
-
-
-
-

() 任务描述

()

()

)	()		

()

()

()

()

()

○

()			

Sailing Schedule from : Shenzhen,Shenzhen,Guangdong,China

To : Los Angeles,Los Angeles,CA,United States

Origin City : Shenzhen,Shenzhen,Guangdong,China

Destination City : Los Angeles,Los Angeles,CA,United States

CY/DOOR

CY/DOOR

序列号	航线	船名	航次	截关时间	装货港	预计离港时间	实际离港时间	卸货港
1	YPSW	YM UNISON	59E	2016-04-22 17:00	Yantian	2016-04-25		Los Angeles
2	SEA	NORTHERN JAVELIN	002E	2016-04-23 12:00	Yantian	2016-04-27		Long Beach
3	AAS2	CMA CGM LIBRA	095TXE	2016-04-25 16:00	Yantian	2016-04-28		Long Beach
4	YPSW	YM UBIQUITY	22E	2016-04-29 17:00	Yantian	2016-05-02		Los Angeles
5	SEA	C SCL PUSAN	117E	2016-04-30 12:00	Yantian	2016-05-04		Long Beach
6	AAS2	CMA CGM COLUMBA	097TXE	2016-05-02 16:00	Yantian	2016-05-05		Long Beach
7	SEA	COSCO NINGBO	069W	2016-05-06 11:00	Yantian	2016-05-08		Long Beach
8	YPSW	YM JIREBY	50E	2016-05-06 17:00	Yantian	2016-05-09		Los Angeles
9	SEA	COSCO EXCELLENCE	027E	2016-05-07 12:00	Yantian	2016-05-11		Long Beach
10	AAS2	CMA CGM CENTAURUS	099TXE	2016-05-09 16:00	Yantian	2016-05-12		Long Beach
11	YPSW	YM MASCULINITY	32E	2016-05-13 17:00	Yantian	2016-05-16		Los Angeles
12	SEA	HONG KONG BRIDGE	039E	2016-05-14 12:00	Yantian	2016-05-18		Long Beach
13	AAS2	CMA CGM THALASSA	101TXE	2016-05-16 16:00	Yantian	2016-05-19		Long Beach



干货箱



	箱体内部尺寸			箱体内容积及载重量		箱门开度尺寸	
	L	W	H	Cu	P	W	H
20'	5898	2352	2393	33.2	21740/28230#	2340	2280
40'	12032	2352	2393	67.7	26630	2340	2280
HC	12032	2352	2698	76.3	26520	2340	2585

冷藏箱



	箱体内部尺寸			箱体内容积及载重量	
	L	W	H	Cu	P
20'	5444	2284	2267	28.5	21135/27160#
40'	11583	2284	2250	58.7	26580
HC	11583	2284	2550	67.9	26380

开顶箱



	箱体内部尺寸			箱体内容积及载重量	
	L	W	P	Cu	P
20	5900	2330	2337	32.6	21740
40	12025	2330	2337	65.8	26410

○

○

() 实施条件

() 考核时量

() 评分细则

1

() 任务描述



		<input type="checkbox"/>	<input type="checkbox"/>	<input type="checkbox"/>	<input type="checkbox"/>

<input type="checkbox"/> <input type="checkbox"/> <input type="checkbox"/> <input type="checkbox"/>							



() 实施条件

() 考核时量

() 评分细则

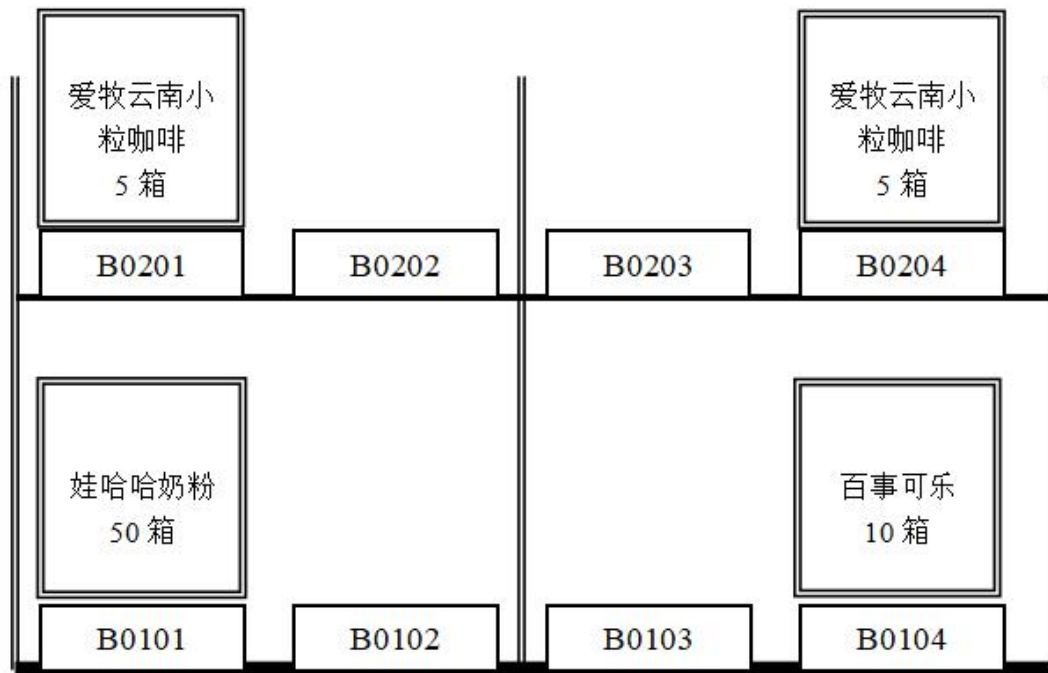
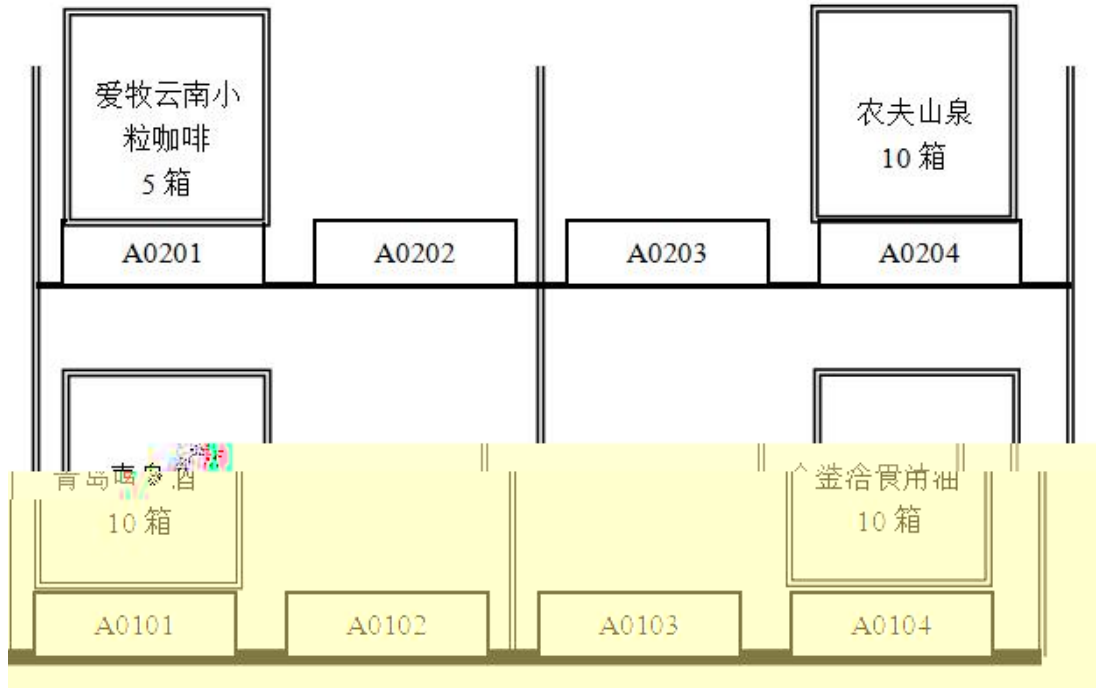

产品运输单

-
-
-
-
-
-
-
-

80				

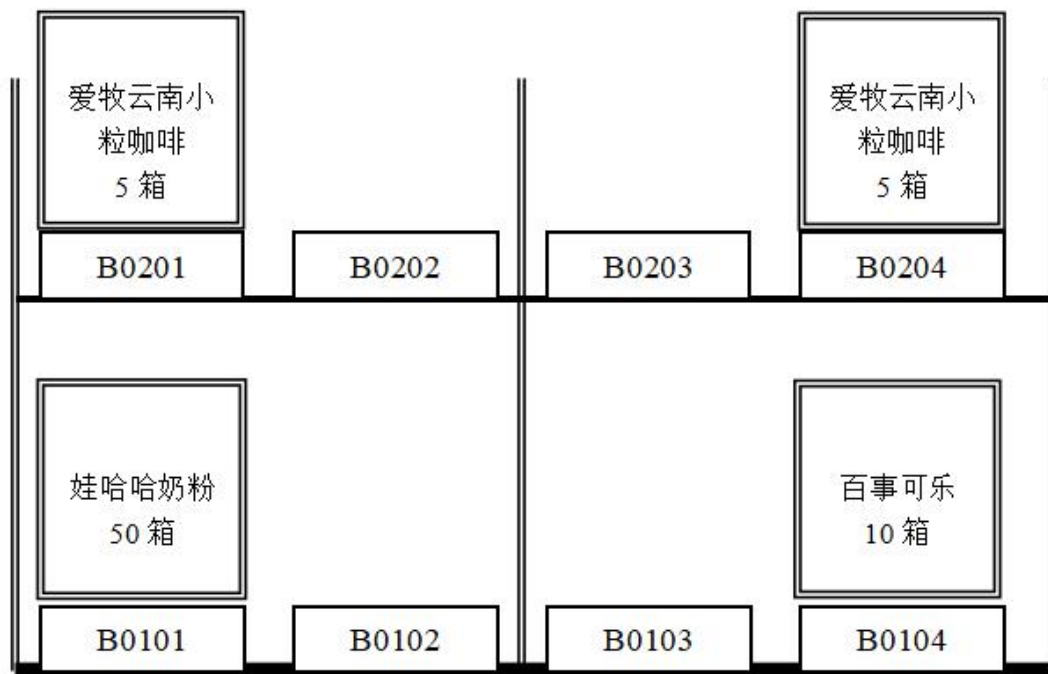

产品运输单

-
-
-
-
-
-
-
-

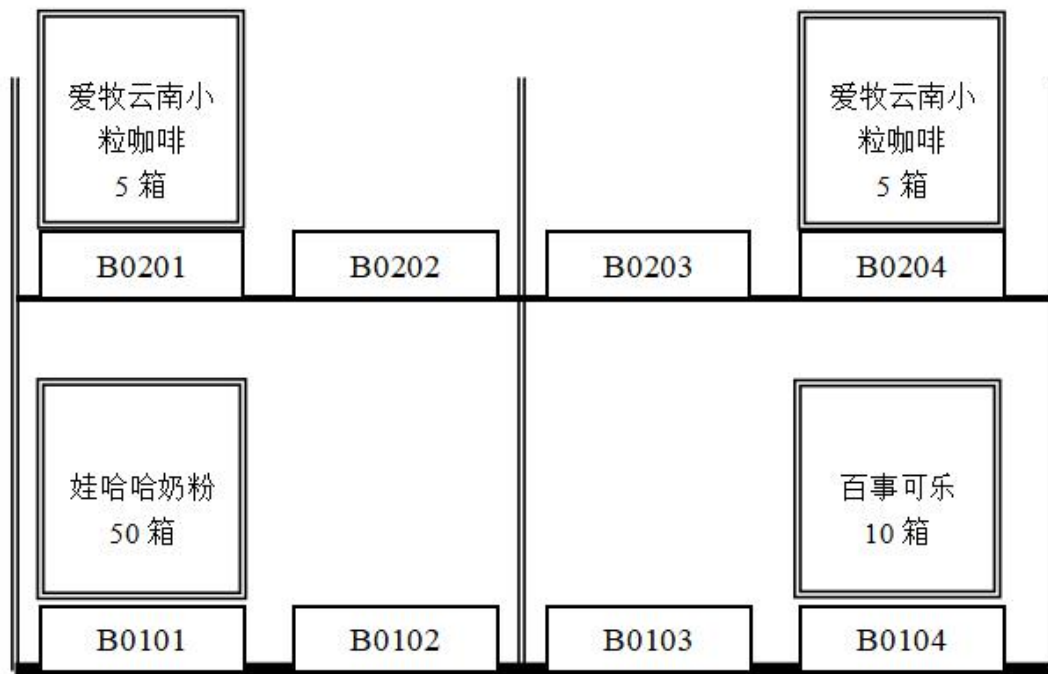
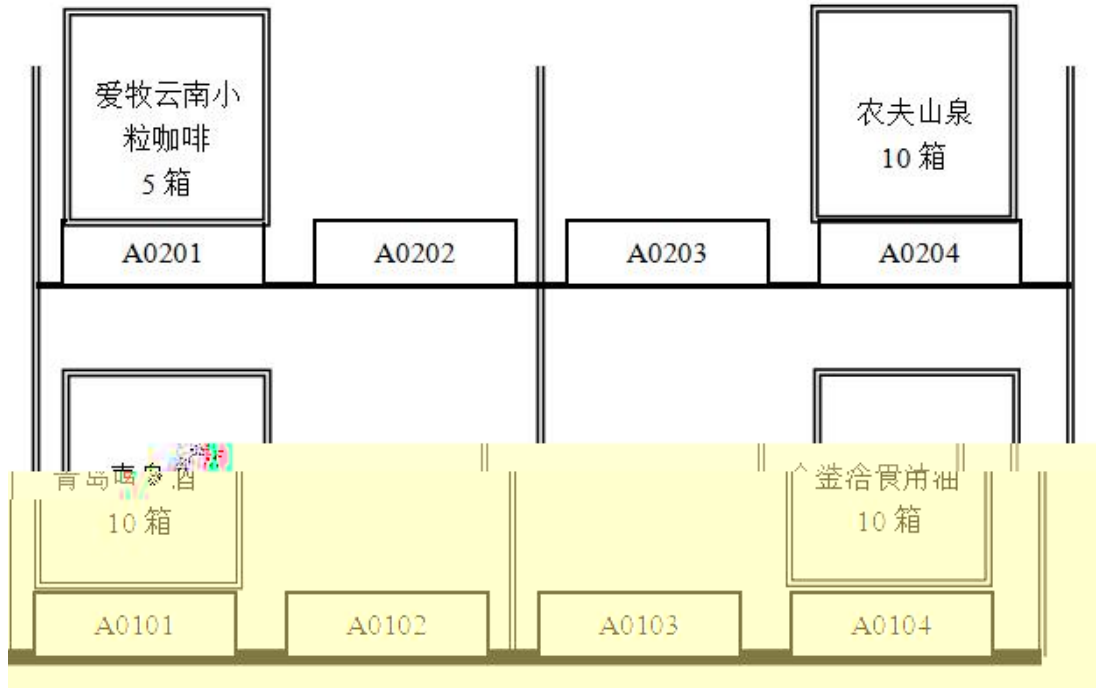

产品运输单

-
-
-
-
-
-
-
-



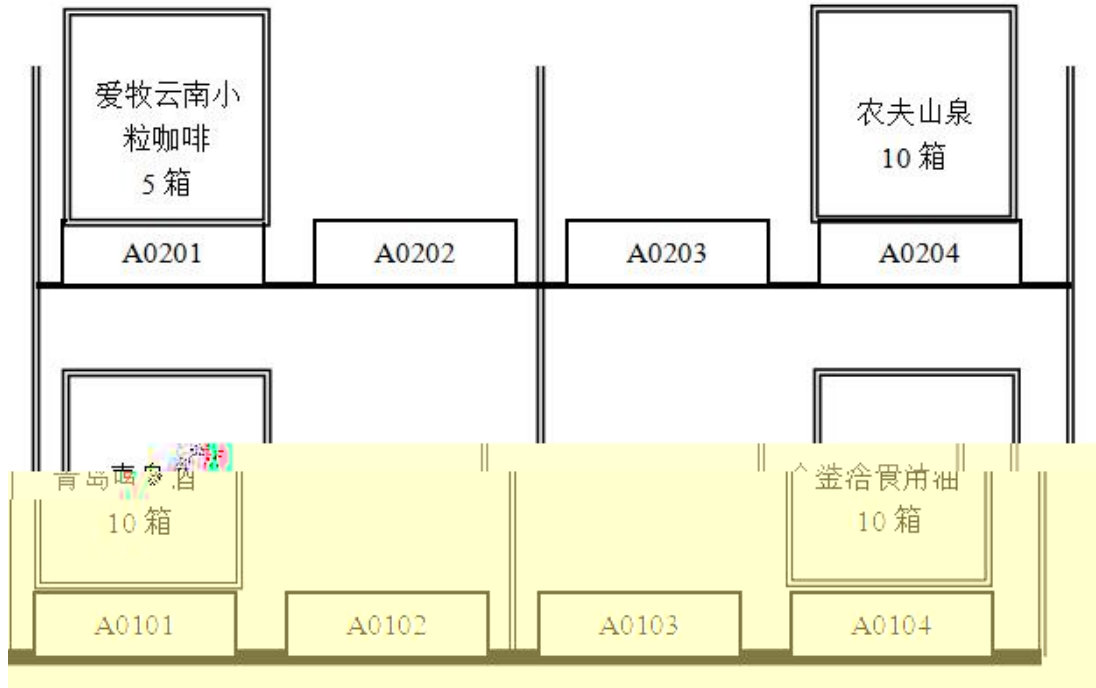

产品运输单

-
-
-
-
-
-
-
-

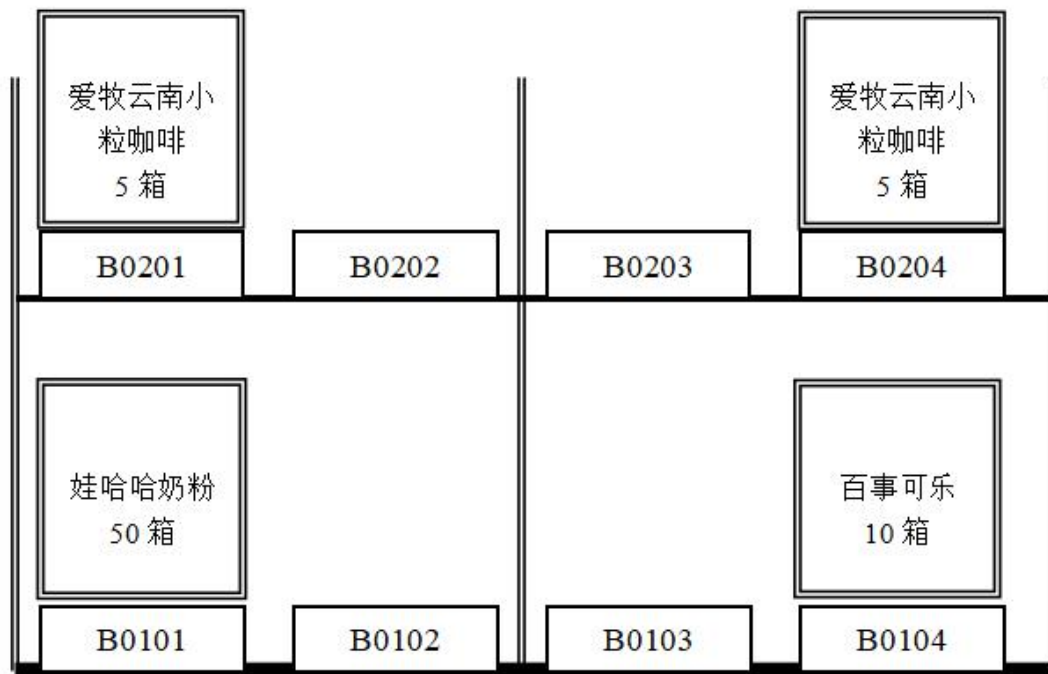
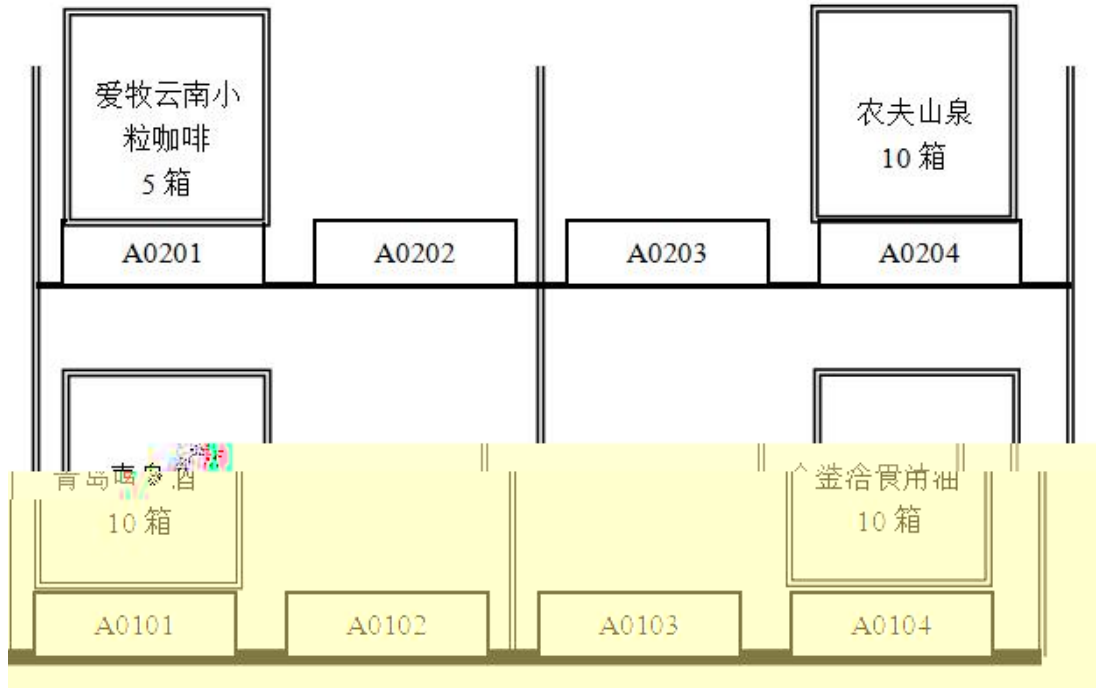

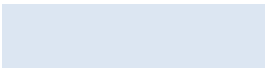

CCW

& 1 (6 2)

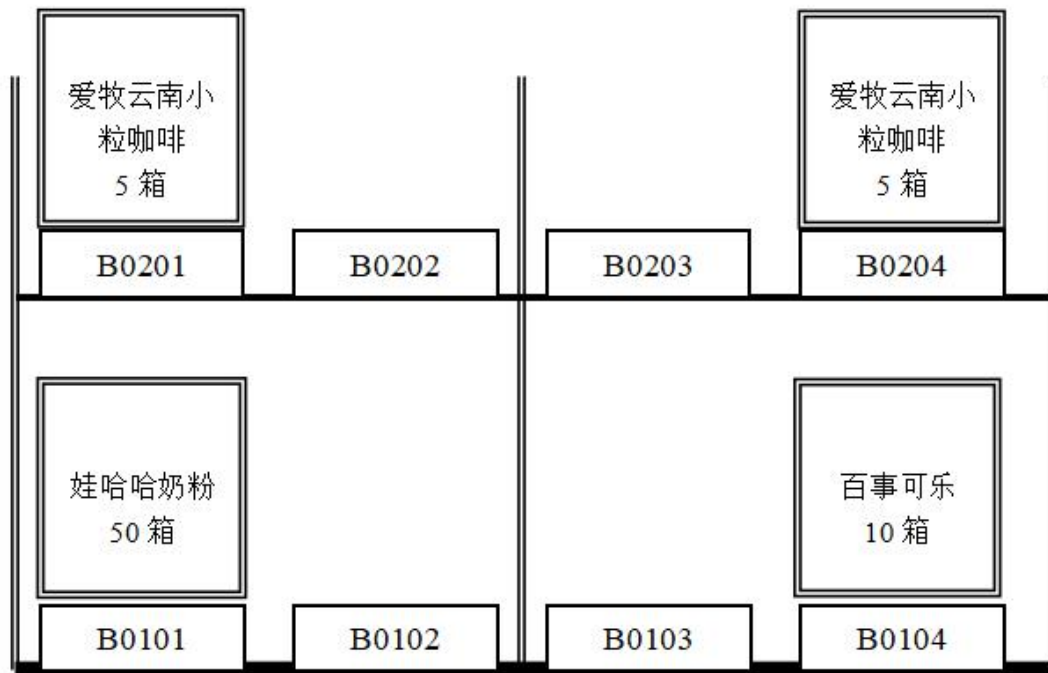
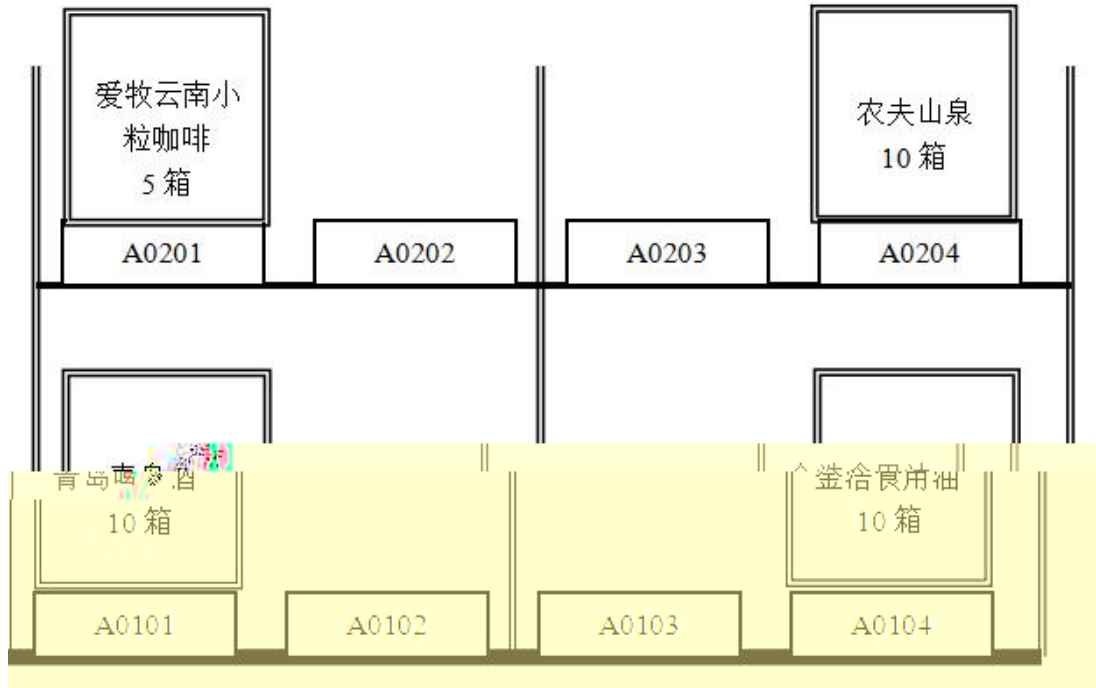

产品运输单

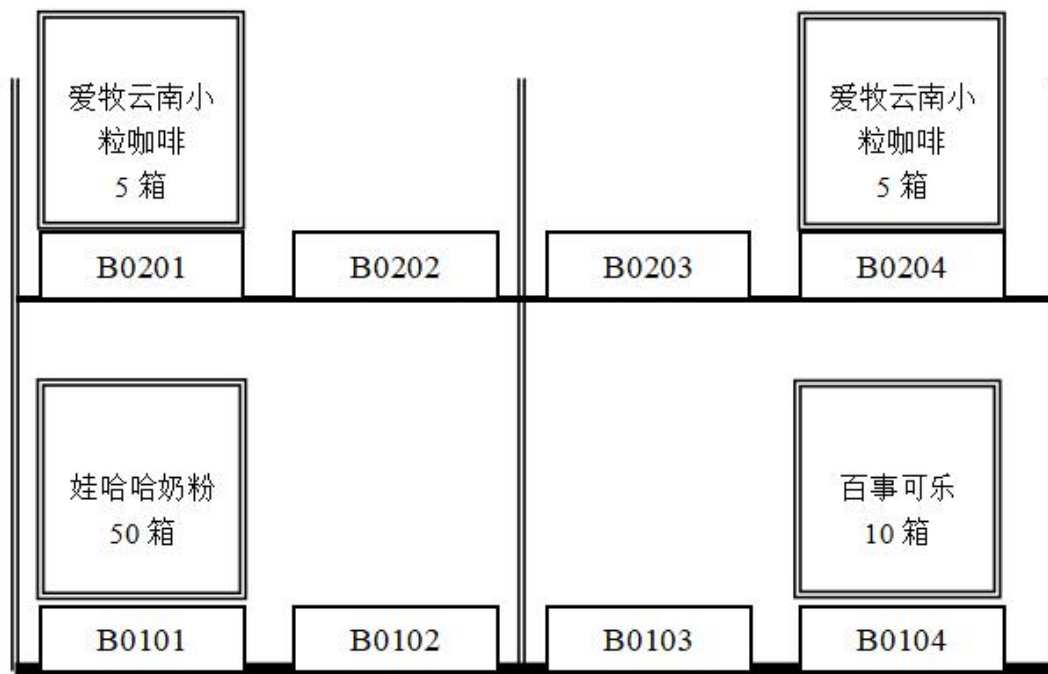
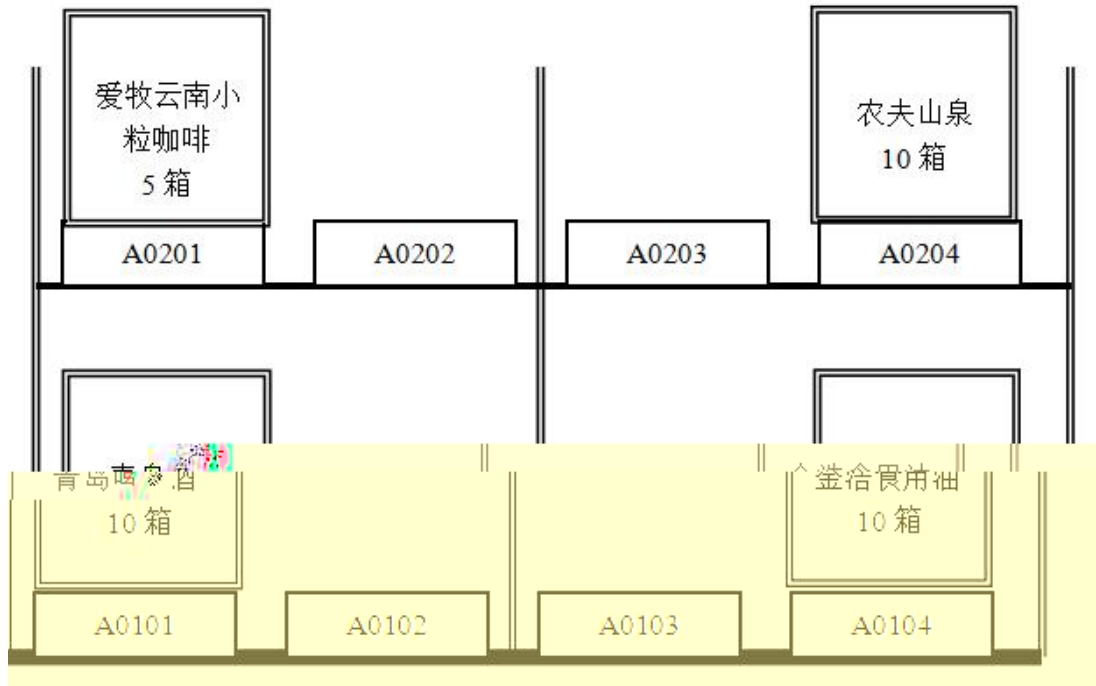

产品运输单

-
-
-
-
-
-
-
-
-

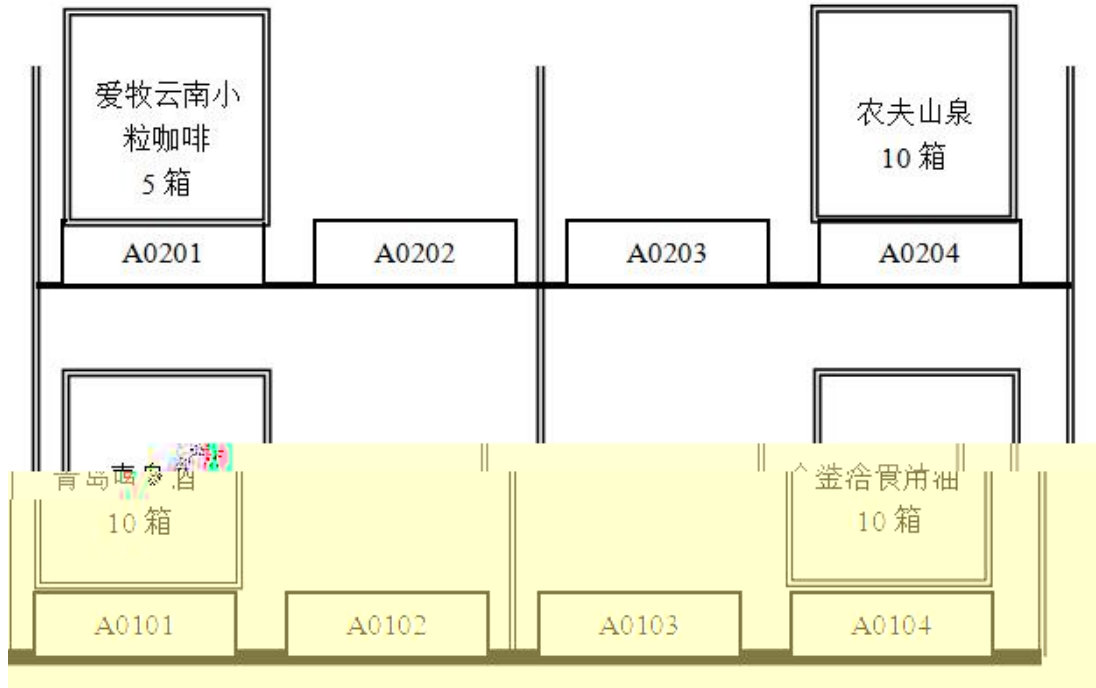

产品运输单

-
-
-
-
-
-
-
-

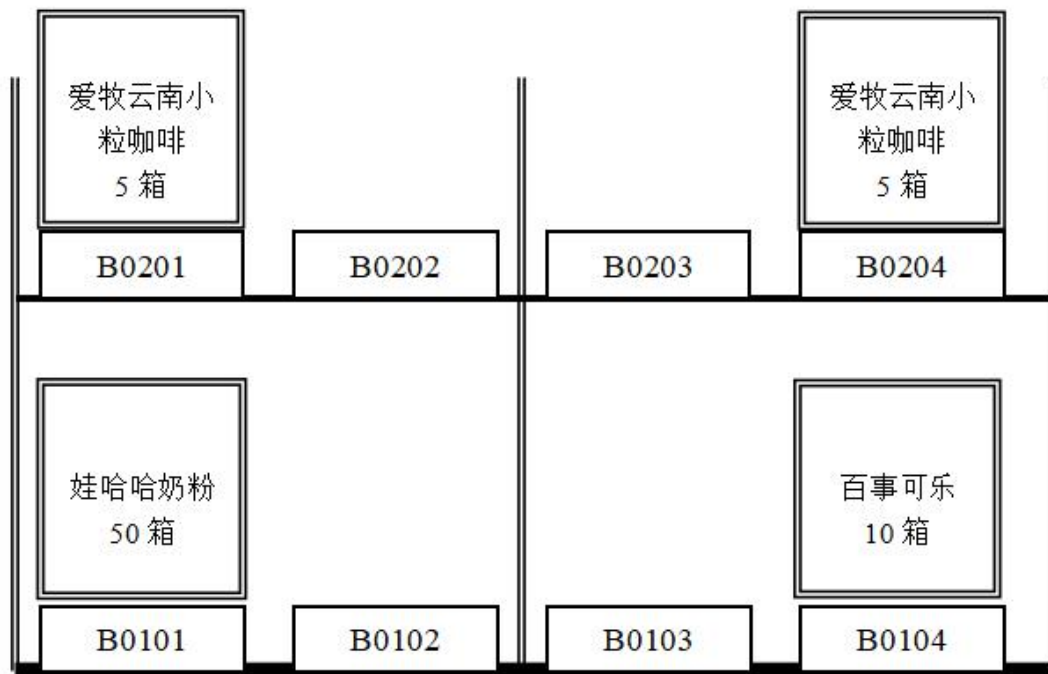
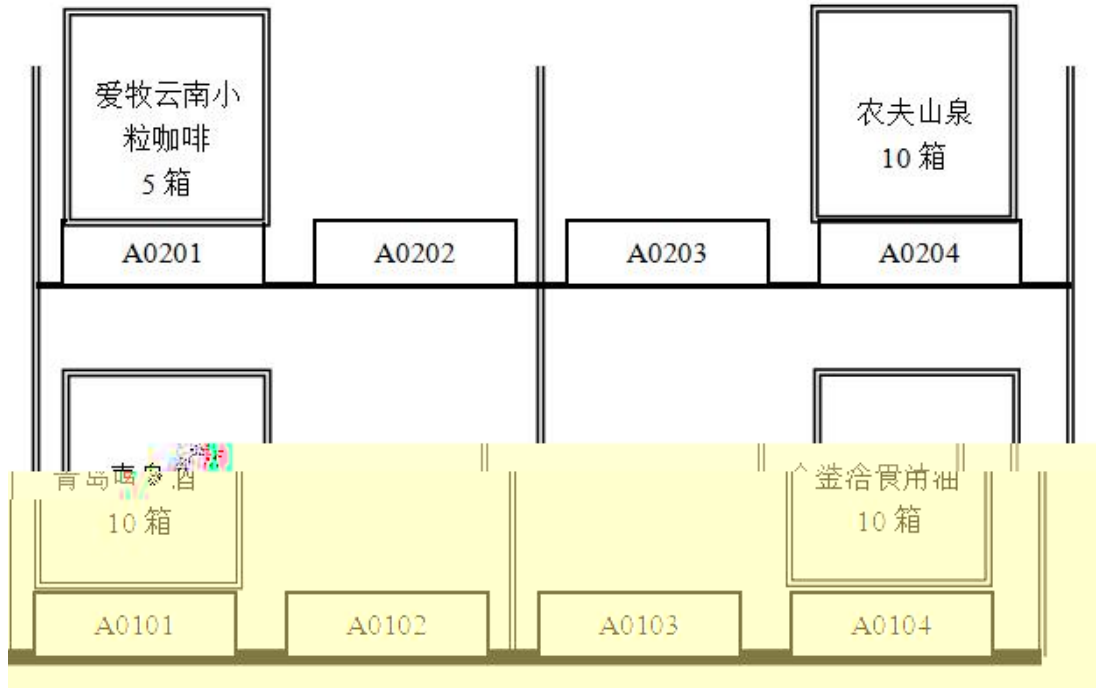

产品运输单

-
-
-
-
-
-
-
-
-

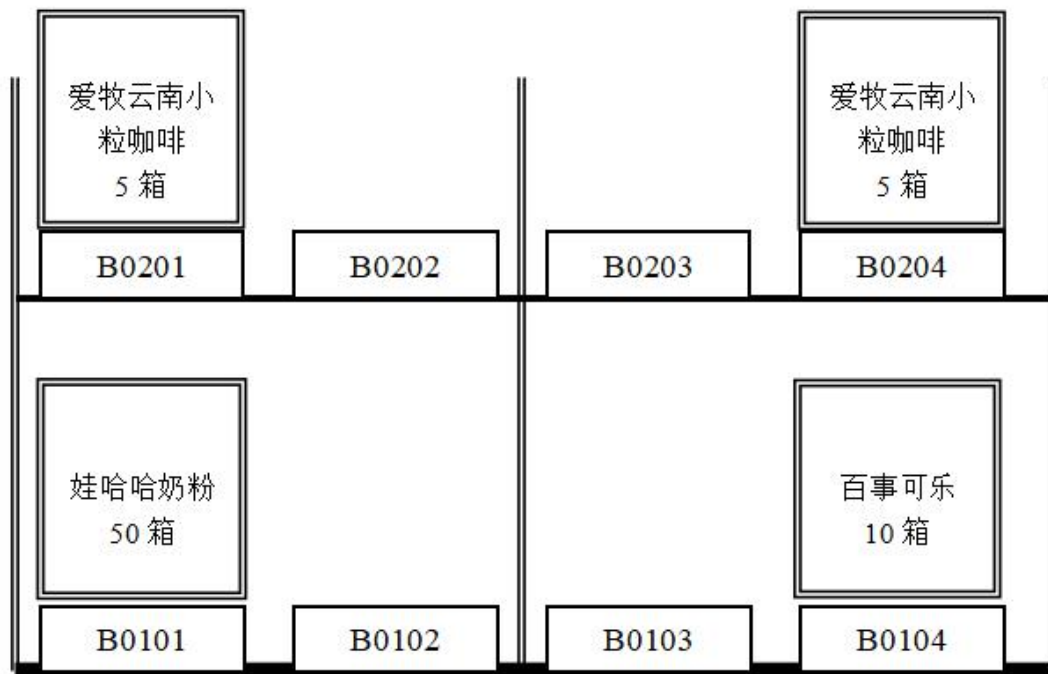
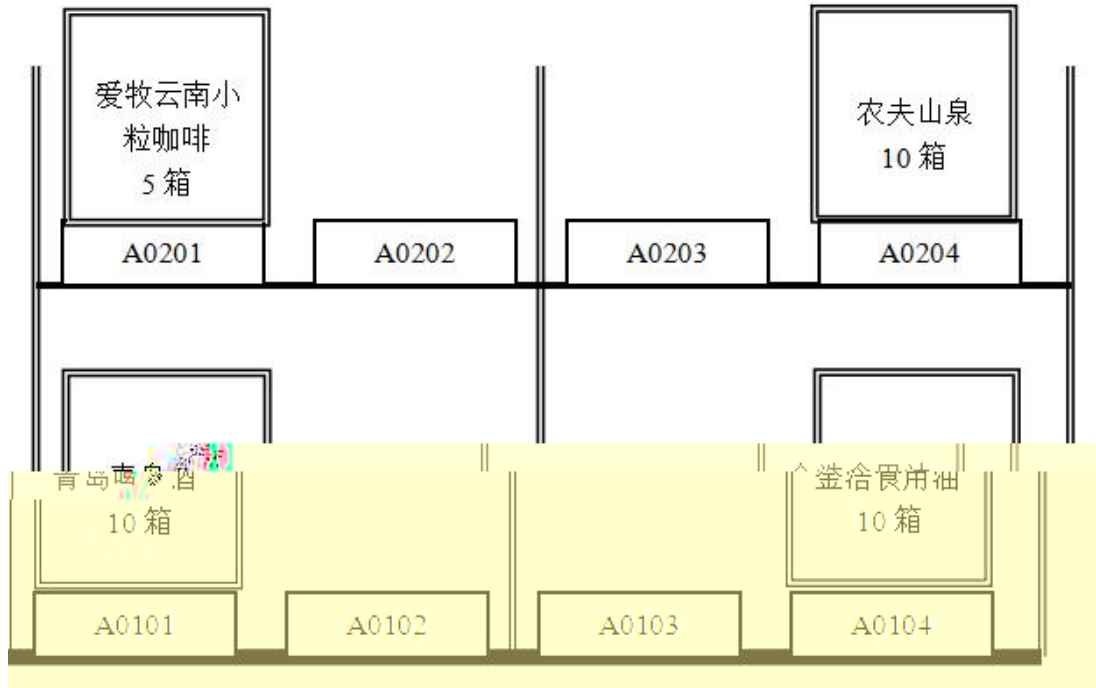

产品运输单

-
-
-
-
-
-
-
-

○

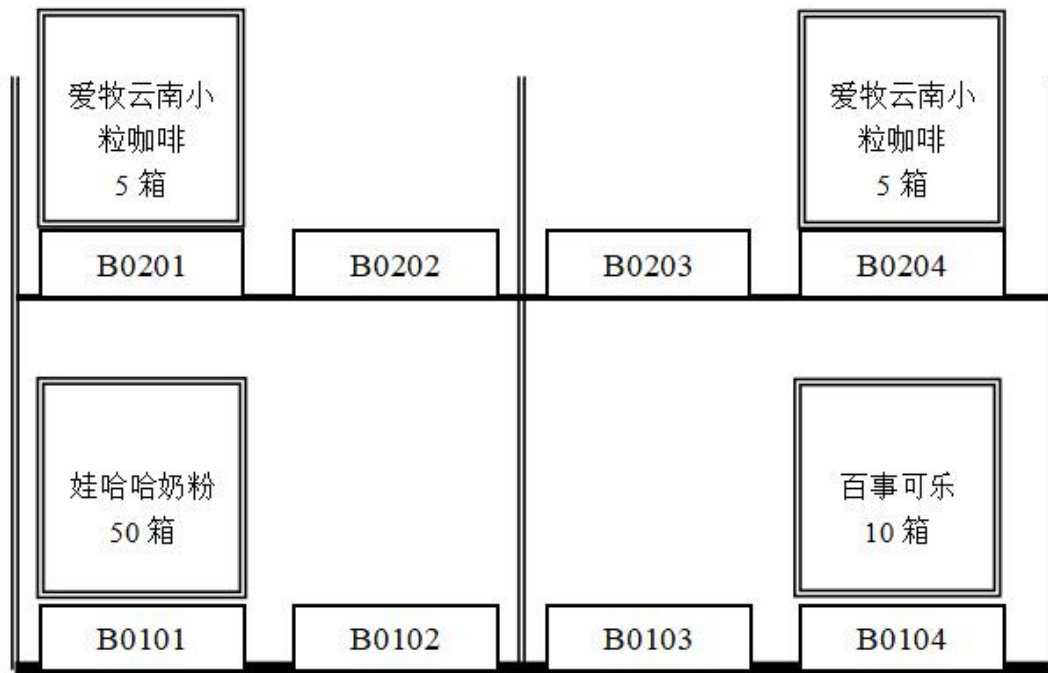
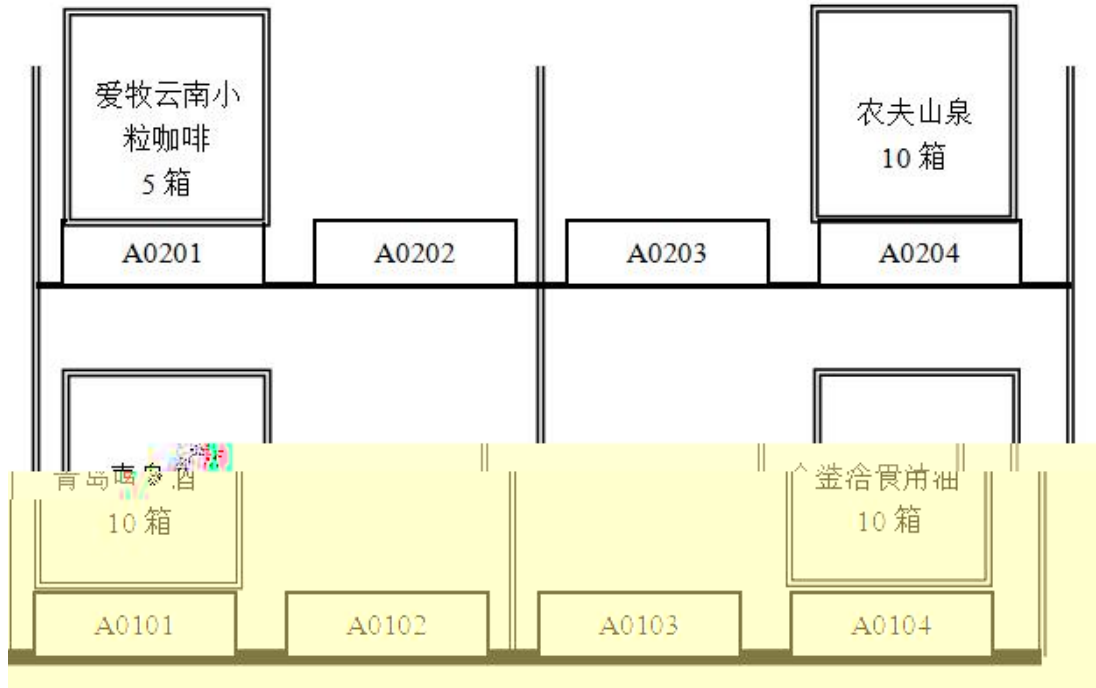



--	--	--	--	--	--

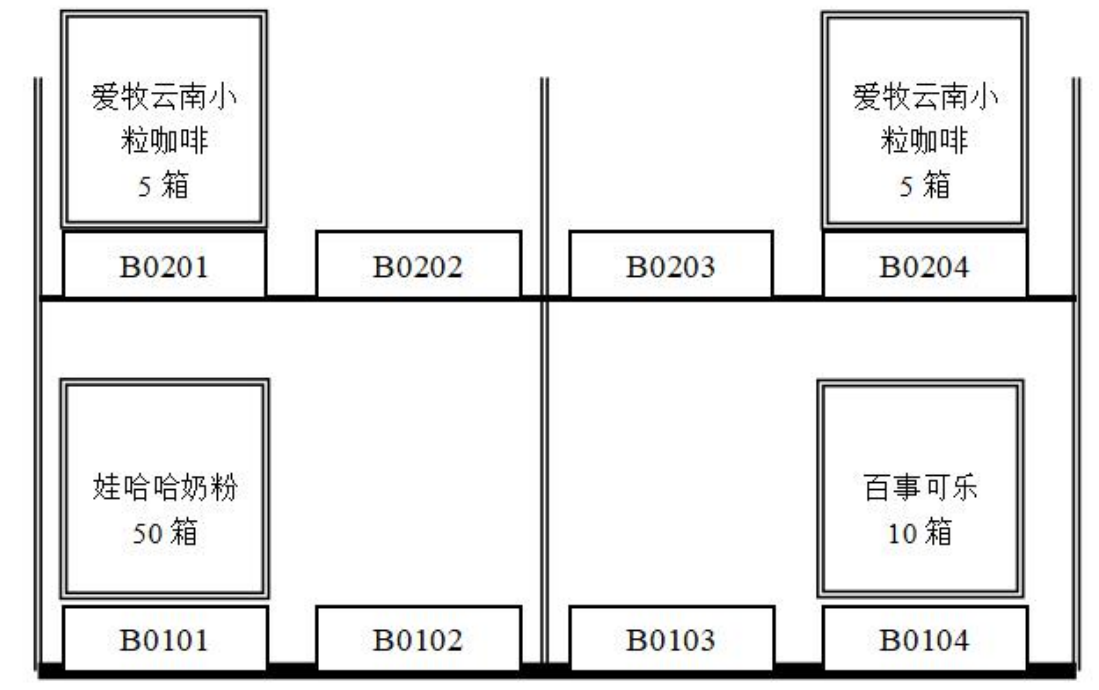
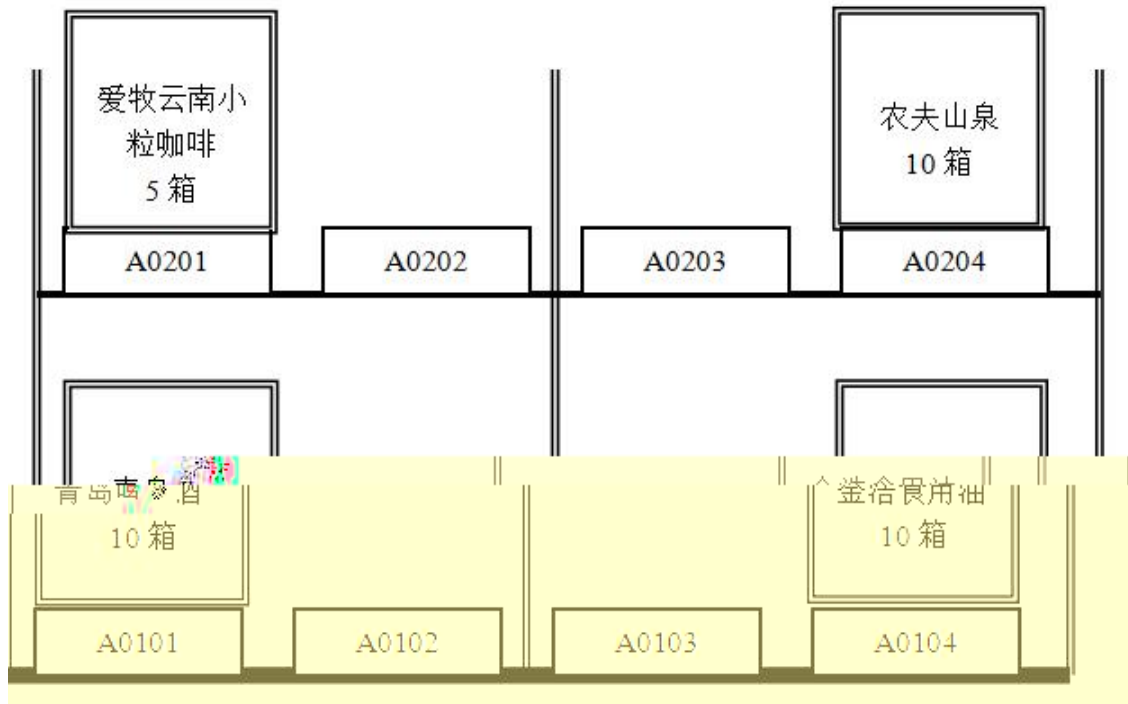

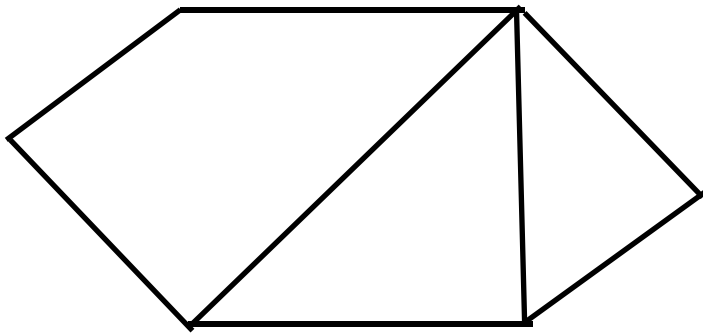

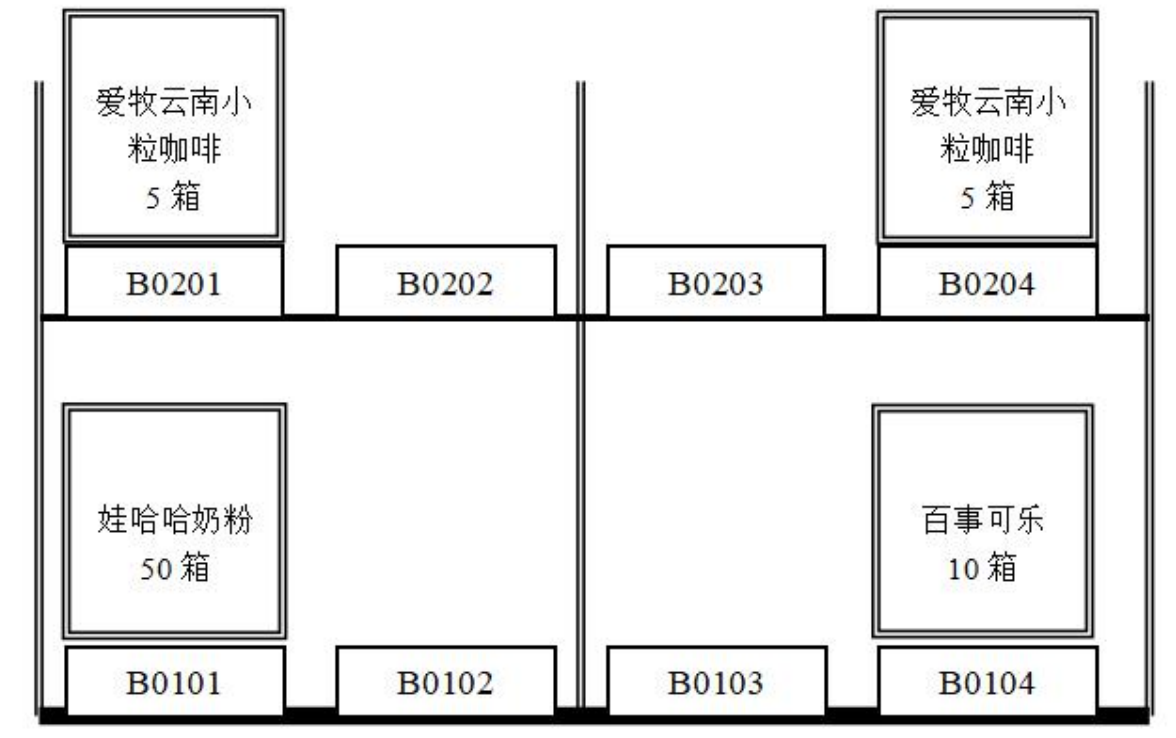
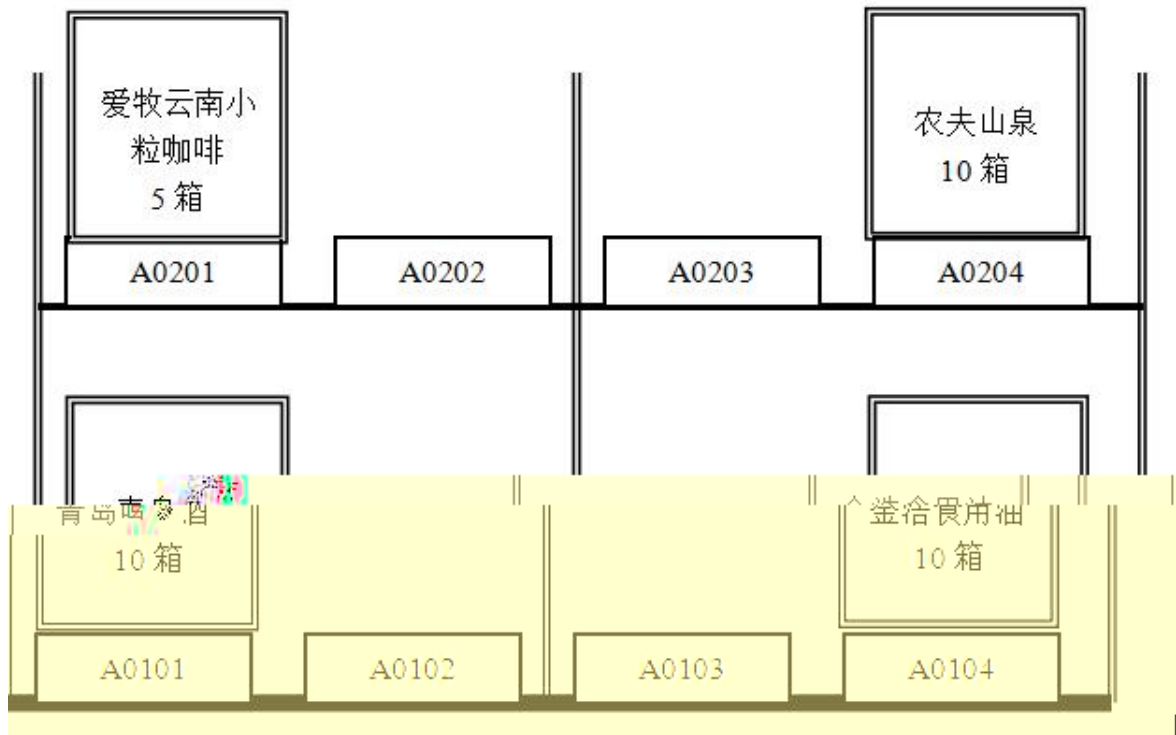

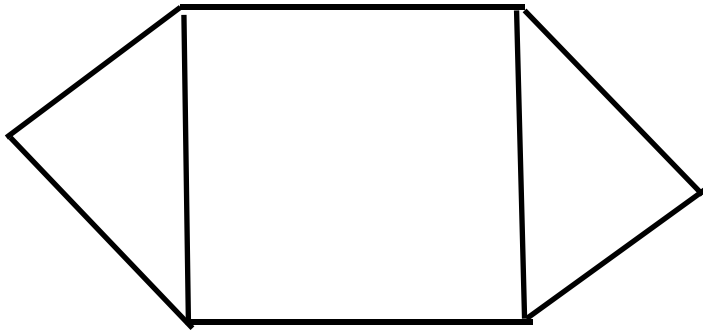

1

		---	---		

		---	---		

--	--

--- ---

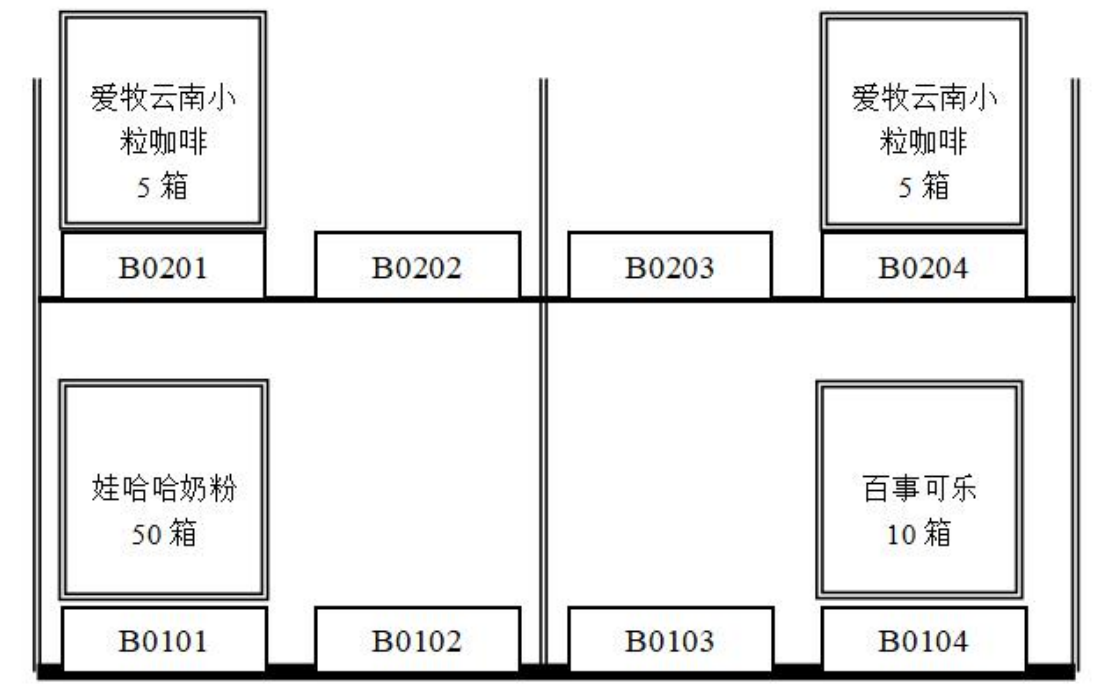
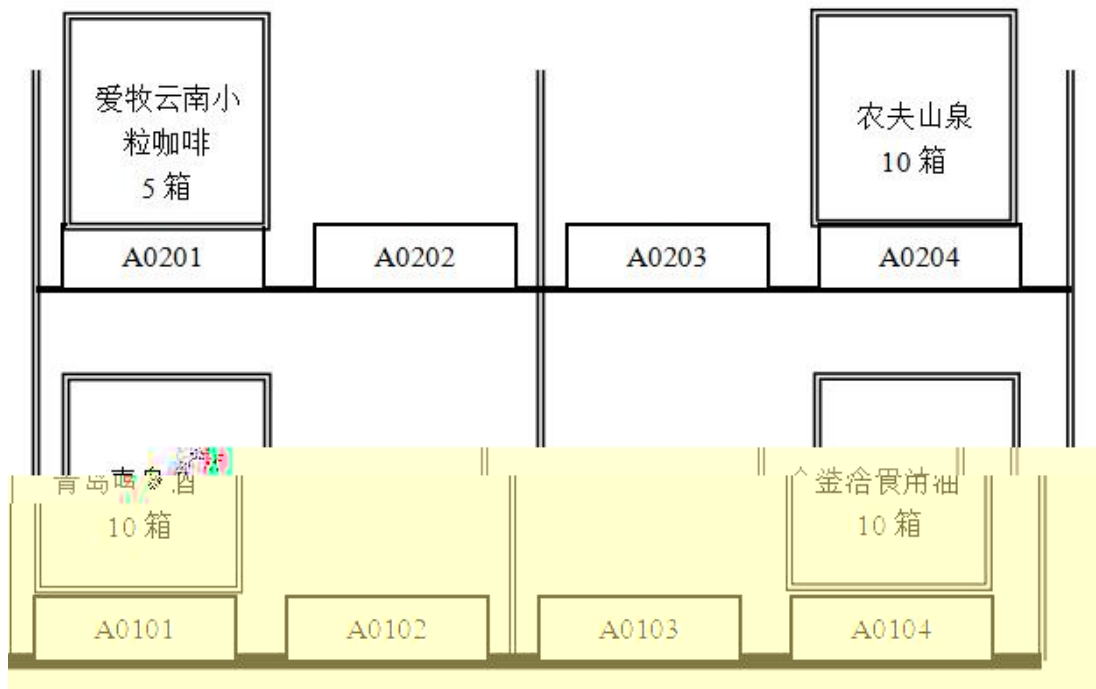

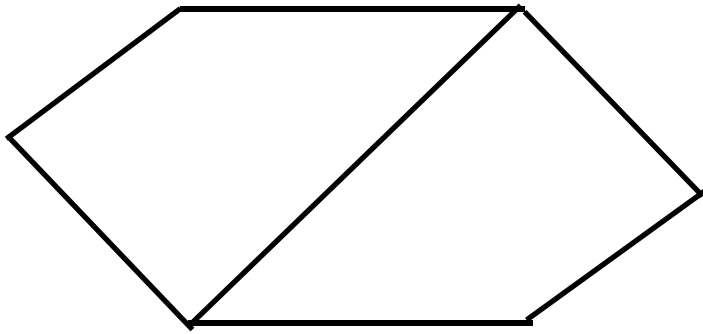

1

--	--	--	--	--	--

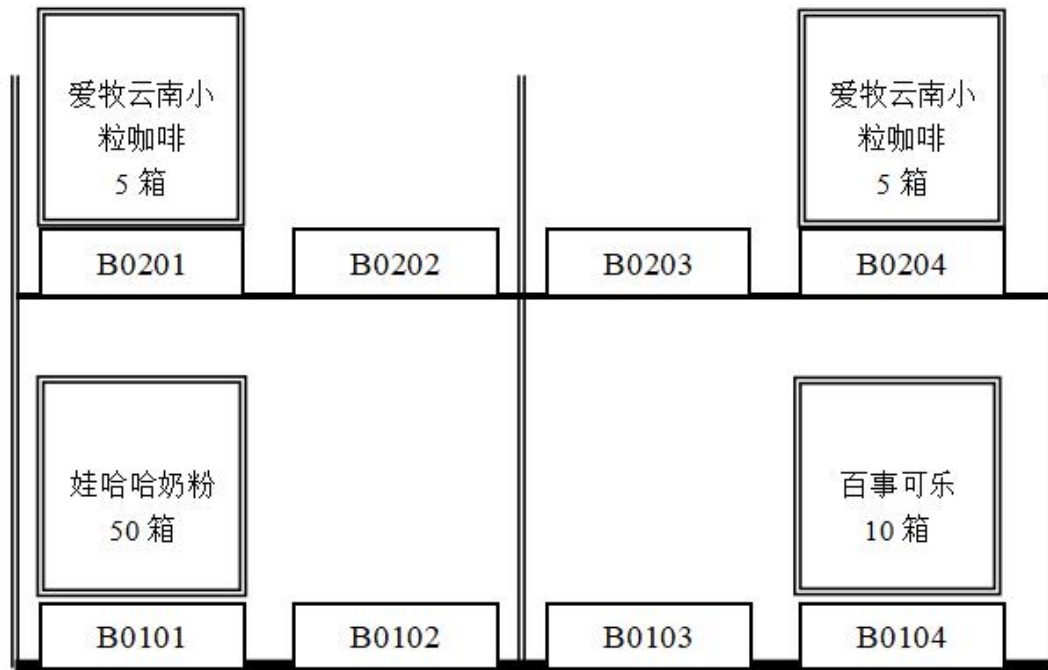
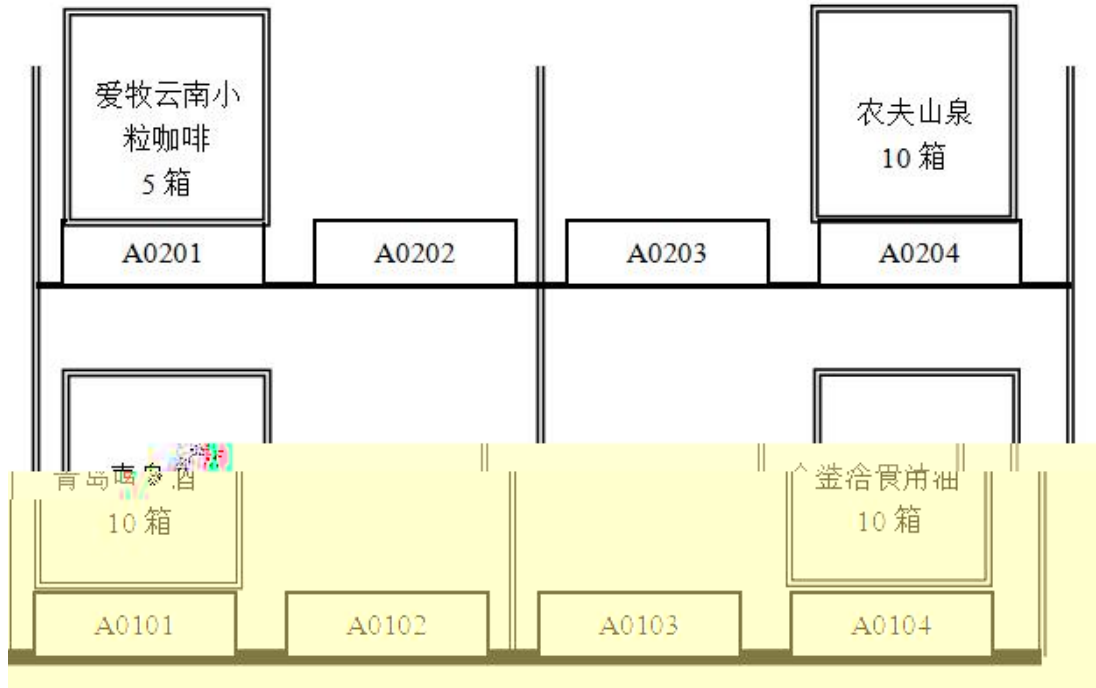

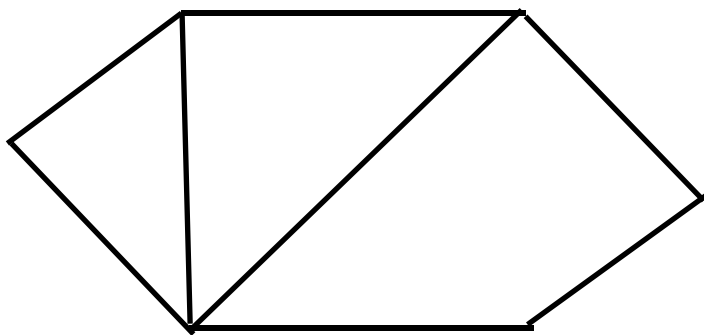

○

○

○

○

○

○

○

○

--	--

○

○

三、国际物流作业组织与管理模块

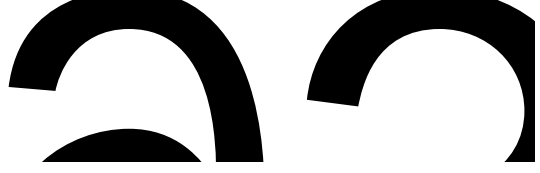

○



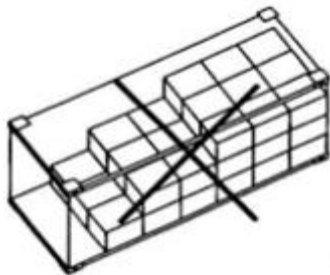
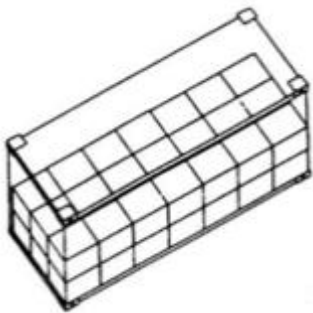

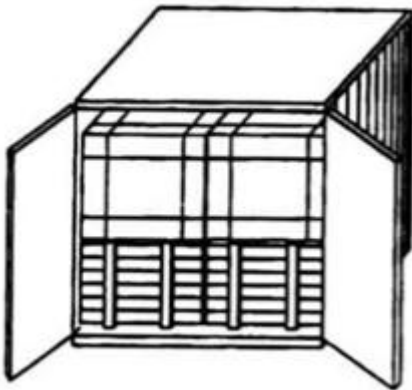
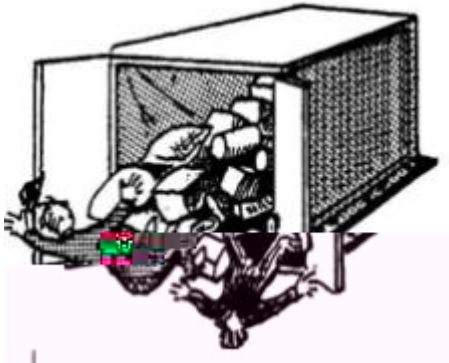
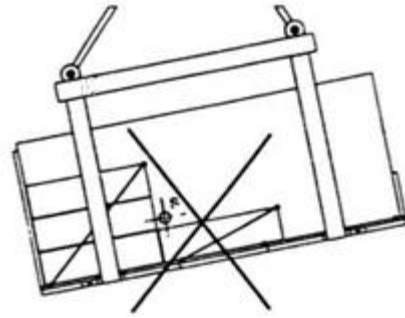

○

船公司 Carrier	船名/航次 Vessel/Voyage	服务代码 Service	航线 Lane	装船港/卸船港 Load/Unload Port	启-达日期 ETD-ETA	天 Day	挂港
MSC 地中海航运	MASTER 409E		中国-香港台	HONG KONG 香港 KAOHSIUNG 高雄	02/25(二) 03/15(六)	18	港外 前港
NYK 日本邮船	ITALIAN EXPRES S/024		中国-东南亚	HONG KONG 香港 BANGKOK 曼谷	02/25(二) 03/02(四)	5	港外 前港
CMA-CGM 达飞轮船	CMA CGM GEMINI CMA49E		中国-非洲	XIAMEN 厦门 DURBAN 德班	02/25(二) 03/27(四)	30	港外 前港
KLINE 川崎汽船	HYUNDAI PLATINUM M/004W		中国-中南美	SHANGHAI 上海 PARANAGUA 巴拉那瓜	02/25(二) 04/09(三)	43	港外 前港
DMS 达飞轮船	COSCO KAOHSIUNG G/GFS46E		中国-澳新	HONG KONG 香港 NOUMEA 努美阿	02/25(二) 04/02(三)	36	港外 前港
RCL 爱海船运	KOTA PERMASAN VPM114		中国-中东/ 波斯湾/印巴	QINGDAO 青岛 MADRAS 马德拉斯	02/28(五) 03/18(二)	18	港外 前港
ZIM 以星轮船	KUO HUNG 311	CHINA_VIETNAM(CYK)	中国-香港台	NINGBO 宁波 HONG KONG 香港	02/25(二) 03/15(六)	18	港外 前港
SAFMARINE 比利时高航	HEIKE P 1404		中国-非洲	KAOHSIUNG 高雄 MINDELO	02/25(二) 04/05(六)	39	港外 前港
CSAV 常荣船务	CAP SAN NICOLA S/01409		中国-中南美	SHANGHAI 上海 RIO GRANDE 里奥格兰德	02/25(二) 04/07(一)	41	港外 前港
OOCL 东方海外	DRESDEN EXPRES S/16E08	Pacific Atlantic (PAX)	中国-澳东	SHANGHAI 上海 HALIFAX 哈利法克斯	02/25(二) 04/14(一)	48	港外 前港

○
○

BEIJING	CN		BJ\$
Y. RENMINBI	CNY		KGS
		100	100.00
		200	200.00
		300	300.00
		400	400.00
		500	500.00
		600	600.00
		700	700.00
		800	800.00
		900	900.00
		1000	1000.00

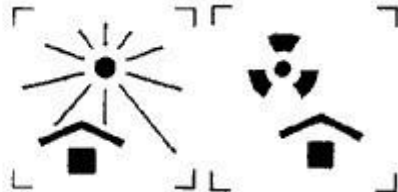
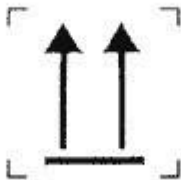
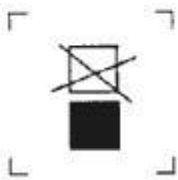

○











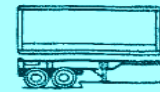

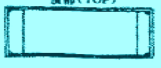

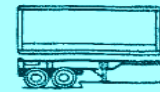

○

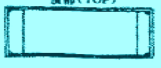
○

集装箱设备交接单
EQUIPMENT INTERCHANGE RECEIPT

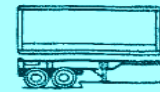
OUT 出场

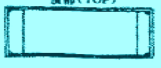
No.

用箱人/运箱人(CNTR. USER/HAULIER)		提箱地点(PLACE OF DELIVERY)																
发往地点(DELIVERED TO)		返回/收箱地点(PLACE OF RETURN)																
船名/航次(VESSEL/VOYAGE No.)	集装箱号(CNTR. No.)	尺寸/类型(SIZE/TYPE)	营运人(CNTR. OPTR)															
箱号(PLATE No.)	箱号(PLATE No.)	箱封号(SEAL No.)	免费期限(FREE TIME PERIOD)															
货重(CARGO W.)		出场目的/状态(PPS OF GATE-OUT/STATUS)	进场目的/状态(PPS OF GATE-IN/STATUS)															
		出场日期(TIME-OUT) 月 日 时																
出场检查记录(INSPECTION AT THE TIME OF INTERCHANGE)																		
普通集装箱(GP. CNTR.)	冷藏集装箱(REF. CNTR.)	特种集装箱(SPL. CNTR.)	发电机(GEN. SET)															
<input type="checkbox"/> 正常(SOUND) <input type="checkbox"/> 异常(DEFFECTIVE)	<input type="checkbox"/> 正常(SOUND) <input type="checkbox"/> 异常(DEFFECTIVE)	设定温度(SET) 记录温度(RECORDED)	<input type="checkbox"/> 正常(SOUND) <input type="checkbox"/> 异常(DEFFECTIVE)															
损坏记录及代号(DAMAGE CODE)																		
<table border="0" style="width:100%;"> <tr> <td align="center">BR 破损 (BROKEN)</td> <td align="center">D 凹痕 (DENT)</td> <td align="center">M 丢失 (MISSING)</td> <td align="center">DR 污损 (DIRTY)</td> <td align="center">DL 标签 (DGLABEL)</td> </tr> <tr> <td align="center">左侧(LEFT SIDE) </td> <td align="center">右侧(RIGHT SIDE) </td> <td align="center">前端(FRONT) </td> <td align="center" colspan="2">内部(INSIDE) </td> </tr> <tr> <td align="center">顶部(TOP) </td> <td align="center">底部(FLOOR BASE) </td> <td align="center">后端(REAR) </td> <td align="center" colspan="2">如有异状, 请注明程度及尺寸(REMARK)</td> </tr> </table>				BR 破损 (BROKEN)	D 凹痕 (DENT)	M 丢失 (MISSING)	DR 污损 (DIRTY)	DL 标签 (DGLABEL)	左侧(LEFT SIDE) 	右侧(RIGHT SIDE) 	前端(FRONT) 	内部(INSIDE) 		顶部(TOP) 	底部(FLOOR BASE) 	后端(REAR) 	如有异状, 请注明程度及尺寸(REMARK)	
BR 破损 (BROKEN)	D 凹痕 (DENT)	M 丢失 (MISSING)	DR 污损 (DIRTY)	DL 标签 (DGLABEL)														
左侧(LEFT SIDE) 	右侧(RIGHT SIDE) 	前端(FRONT) 	内部(INSIDE) 															
顶部(TOP) 	底部(FLOOR BASE) 	后端(REAR) 	如有异状, 请注明程度及尺寸(REMARK)															
<p align="center">除列明者外, 集装箱设备交接时完好无损, 相对完整无误。 EXCEPT OTHERWISE STATED, CONTAINERS INTERCHANGED IN SOUND CONDITION AND SEAL INTACT UNLESS OTHERWISE STATED</p> <p>用箱人/运箱人签署 (CONTAINER USER/HAULIER'S SIGNATURE) 码头/堆场值班员签署 (TERMINAL/DEPOT CLERK'S SIGNATURE)</p> <p align="right">CONTAINER USER/HAULIER'S SIGNATURE</p>																		
____月____日	____年____月____日	____年____月____日	____年															

--	--	--	--	--	--

--	--	--

--	--	--	--	--	--

--	--	--	--	--	--

--	--	--	--	--	--	--	--

○

WORLD

RE



Äc,U,,5V^]1 YE @ 8EX@P 4ÿ

○

--	--	--

--	--	--	--	--	--

○

○

○

○

四、 快递物流作业组织与管理模块

--	--	--	--	--	--



出示身份证件实名信息录入，确保信息安全

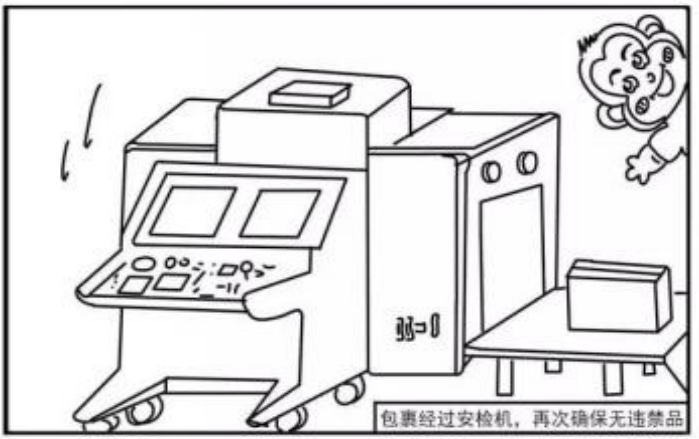

包裹经过安检机，再次确保无违禁品



宅急送，致力于成为中国最有价值的综合物流服务商

--	--	--	--	--	--

--	--	--	--	--	--

[想知道:中国成都理工大学校园快递具体在哪? 百度知道](#)

3个回答 - 提问时间: 2014年02月10日

最佳答案:韵达在银杏后面。宝盒、圆通、顺丰在电影院后面。中通、申通在图书馆下面。常用的是这几个。

[zhidao.baidu.com/link?... 2014-02-15](#) - 百度快照 - 80%好评

--	--	--	--

--	--	--	--



